

LED Recess Step

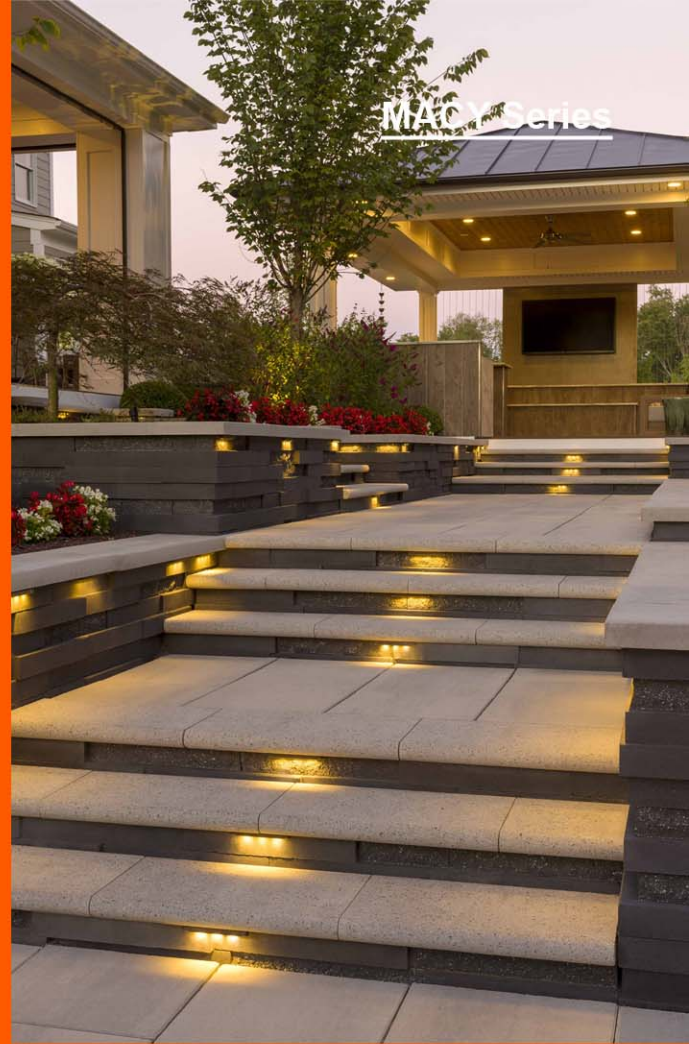

MAC Series

Wall Lighting Selection



LED Recess Wall Mounted Step Lighting

AC220-240V 50/60 Hz PF >0.9 Ra>80 IP65

3000-3500K 4000-4500K 5000-5500K 6000-6500K

B-BOX



MATERIALS/FINISHES:

- Body in extruded aluminum
- Powder coated for outdoor use
- Diffuser in Prismatic temper glass
- Silicon rubber gasket
- LED driver certified CE/SAA

LED Color:

- 3000K
- 4000K

LED Driver included

Diffuser Material:

Prismatic temper glass

Outlook Color:

- Black
 - Light Grey
 - Silver Grey
 - Dark Grey
 - White
- RAL9005 RAL7047 RAL9006 RAL7012 RAL9016

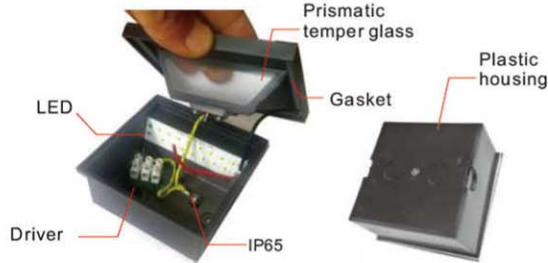

FEATURES:

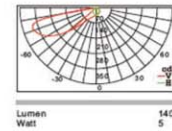
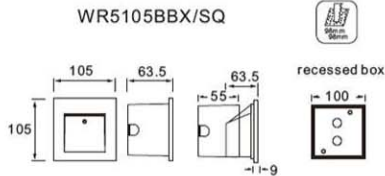
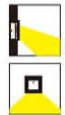

SMD2835 LED, Driver included

5

Item No.	Watt	LED	Kelvin	Luminous flux	Beam Angle	CRI	Input	Safety type
WR5105BBX/SQ	5W	SMD 15LED	3000K or 4000K	140lm	36°	≥80	100-240V	IP65

BRIX.WR



MATERIALS/FINISHES:

- Body in extruded aluminum
- Powder coated for outdoor use
- Diffuser in Prismatic temper glass
- Silicon rubber gasket
- LED driver certified CE/SAA

LED Color:

- 3000K
- 4000K

LED Driver included

Diffuser Material:

Prismatic temper glass

Outlook Color:

- Black
 - Light Grey
 - Silver Grey
 - Dark Grey
 - White
- RAL9005 RAL7047 RAL9006 RAL7012 RAL9016

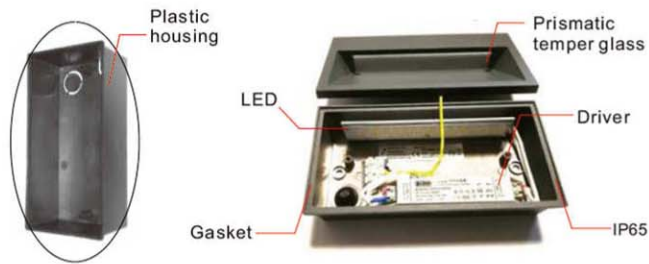

FEATURES:

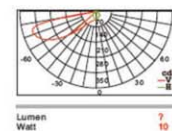
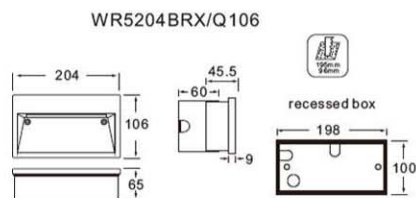
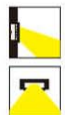

SMD2835 LED, Driver included

5

Item No.	Watt	LED	Kelvin	Luminous flux	Beam Angle	CRI	Input	Safety type
WR5204BRX/Q106	10W	SMD 48LED	3000K or 4000K	377.29 lm	78.9°	≥80	220-240V	IP65

2020 Version

LED Recess Wall Mounted Step Lighting

AC220-240V 50/60 Hz PF >0.9 Ra>80 IP65

3000-3500K 4000-4500K 5000-5500K 6000-6500K

BEDALE

IP65



MATERIALS/FINISHES:

- Body in die cast aluminum
- Powder coated for outdoor use
- Diffuser in Frost temper glass
- Silicon rubber gasket
- LED driver certified CE/SAA

LED Color: 3000K/4000K

- 3000K
- 4000K

LED & Drivers:

- LED Driver included
- Application Picture

LED Type:

- SMD 2835

Diffuser Material: Frost temper glass

Outlook Color:

- Black
 - Light Grey
 - Silver Grey
 - Dark Grey
 - White
- RAL9005 RAL7047 RAL9006 RAL7012 RAL9016

FEATURES:

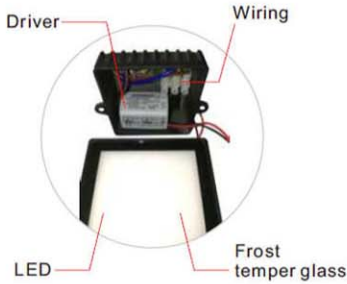

WALL RECESSED TYPE



WR5140BDL/LQ70

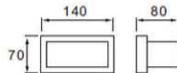

Item No.	Watt	LED	Kelvin	Luminous flux	Beam Angle	CRI	Input	Safety type
WR5140BDL/LQ70	4W	SMD40LEDs	or 3000K 4000K	130lm	---°	≥80	220-240V	IP65



WR5090BDL/SQ

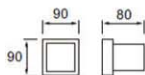

WR5140BDL/SQ

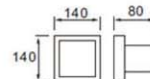

Item No.	Watt	LED	Kelvin	Luminous flux	Beam Angle	CRI	Input	Safety type
WR5090BDL/SQ	3.5W	SMD22LEDs	or 3000K	120lm	---°	≥80	220-240V	IP65
WR5140BDL/SQ	6W	SMD40LEDs	4000K	270lm				

2020 Version

LED Recess Wall Mounted Step Lighting

AC220-240V 50/60 Hz PF >0.9 Ra>80 IP65

3000-3500K 4000-4500K 5000-5500K 6000-6500K

BOVEY



E27



MATERIALS/FINISHES:

- Body in extruded aluminum
- Powder coated for outdoor use
- Diffuser in Frost temper glass
- Silicon rubber gasket
- LED driver certified CE/SAA



- Diffuser Material: Prismatic temper glass

Outlook Color:

- Black
 - Light Grey
 - Silver Grey
 - Dark Grey
 - White
- RAL9005 RAL7047 RAL9006 RAL7012 RAL9016

LED & Drivers:

- LED Driver included
- Application Picture

LED Type:

- SMD 2835

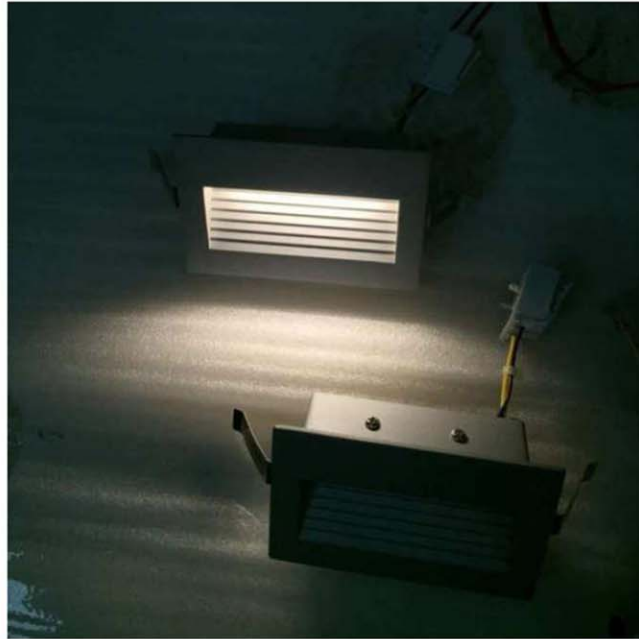

FEATURES:

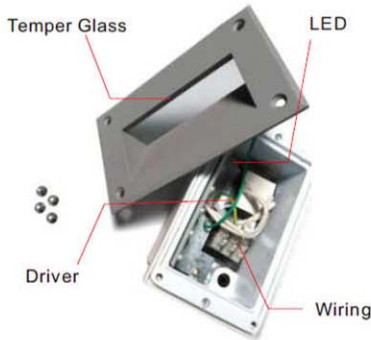

WALL RECESSED TYPE

Item No.	Luminaire	Socket
WR0170BVY	CFL/LED	1*E27

(same to be QA/QB)

- SMD2835 LED Driver included

5



WR5170BVY/QA

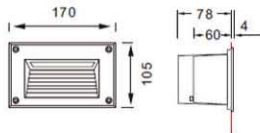

WR5170BVY/QB

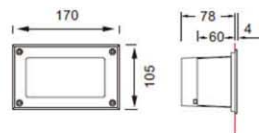

Item No.	Watt	LED	Kelvin	Luminous flux	Beam Angle	CRI	Input	Safety type
WR5170BVY/QA WR5170BVY/QB	3W	SMD2835	3000K or 4000K	78lm 160.9lm	46.28° 122.5°	≥80	100-240V	IP65

Item No.	Luminaire	Length Max.	Socket	Beam Angle	Input	Safety type	Certification
WR0170BVY/Q (the same to be QA/QB)	CFL/LED	L=150mm	E27	---	110V/240V	IP65	CE ETL

2020 Version

LED Recess Wall Mounted Step Lighting

AC220-240V 50/60 Hz PF >0.9 Ra>80 IP65

3000-3500K 4000-4500K 5000-5500K 6000-6500K

BOX

IP65



LED & Drivers:

MATERIALS/FINISHES:

- Body in extruded aluminum
- Powder coated for outdoor use
- Diffuser in Prismatic temper glass
- Silicon rubber gasket
- LED driver certified CE/SAA

LED Color: 3000K/4000K

- 3000K
- 4000K

- LED Driver included
- Application Picture

LED Type:

- SMD 2835

Diffuser Material:

Prismatic temper glass

Outlook Color:

- Black
- Light Grey
- Silver Grey
- Dark Grey
- White

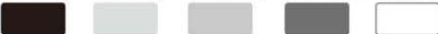

RAL9005 RAL7047 RAL9006 RAL7012 RAL9016

FEATURES:

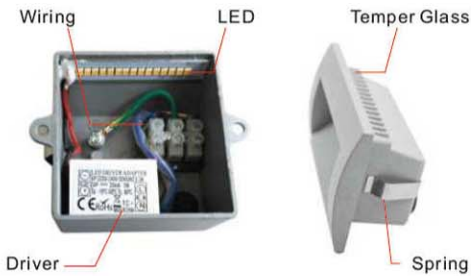

WALL RECESSED TYPE

SMD2835 LED, Driver included

5

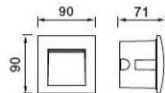
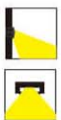

WR5090BOX/SQ

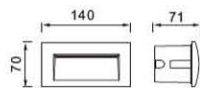

WR5140BOX/Q70

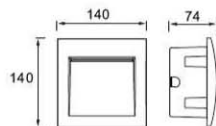

WR5140BOX/SQ

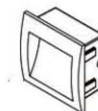

Item No.	Watt	LED	Kelvin	Luminous flux	Beam Angle	CRI	Input	Safety type
WR5090BOX/SQ	1W	SMD15LEDs	3000K	25lm	---°	≥80	220-240V	IP65
WR5140BOX/Q70	3W	SMD15LEDs	or 4000K	90lm	---°			
WR5140BOX/SQ	3W	SMD15LEDs		155lm	---°			

2020 Version

LED Recess Wall Mounted Step Lighting

AC220 ~240V 50/60 Hz PF >0.9 Ra>80 IP65

3000~3500K 4000~4500K 5000~5500K 6000~6500K

BOX.PS

IP65



LED & Drivers:

- MATERIALS/FINISHES:**
 - Body in extruded aluminum
 - Powder coated for outdoor use
 - Diffuser in Prismatic temper glass
 - Silicon rubber gasket
 - LED driver certified CE/SAA
- LED Color:** 3000K/4000K
 - 3000K
 - 4000K

- Diffuser Material:** Prismatic temper glass

- Outlook Color:**
 - Black
 - Light Grey
 - Silver Grey
 - Dark Grey
 - White
- RAL9005 RAL7047 RAL9006 RAL7012 RAL9016

- LED Driver included**
- Application Picture**

- LED Type:** SMD 2835



FEATURES:

SENSOR:

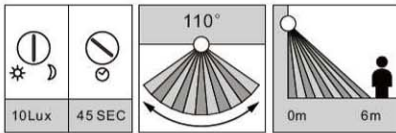

WALL RECESSED TYPE

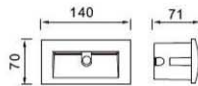
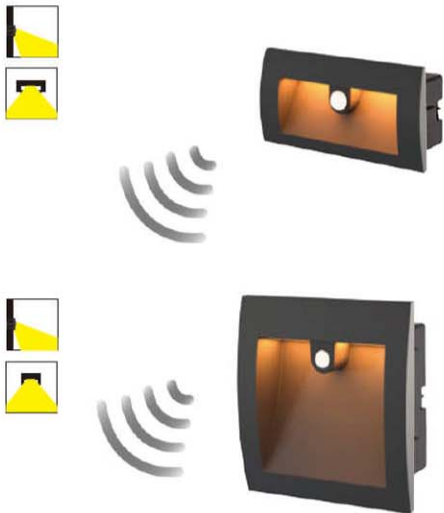

WR5140BOX/Q.PS

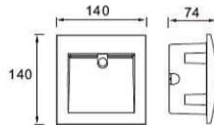

WR5140BOX/SQ.PS



Item No.	Watt	LED	Kelvin	Luminous flux	Beam Angle	CRI	Input	Safety type
WR5140BOX/Q.PS WR5140BOX/SQ.PS	6.5W	SMD2835	or 3000K 4000K	150lm	---° ---° ---°	≥80	220-240V	IP65

2020 Version

LED Recess Wall Mounted Step Lighting

AC220-240V 50/60 Hz PF >0.9 Ra>80 IP65

3000-3500K 4000-4500K 5000-5500K 6000-6500K

CATANIA



E27



LED & Drivers:

MATERIALS/FINISHES:

- Body in extruded aluminum
- Powder coated for outdoor use
- Diffuser in Prismatic temper glass
- Silicon rubber gasket
- LED driver certified CE/SAA



Diffuser Material:

Prismatic temper glass

Outlook Color:

- Black
 - Light Grey
 - Silver Grey
 - Dark Grey
 - White
- RAL9005 RAL7047 RAL9006 RAL7012 RAL9016

FEATURES:

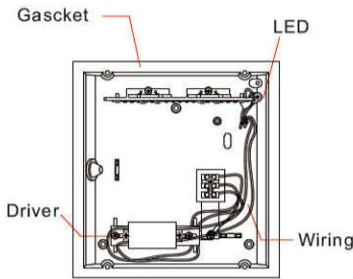

LED Driver included

LED Type:

Application Picture

- CREE XBD

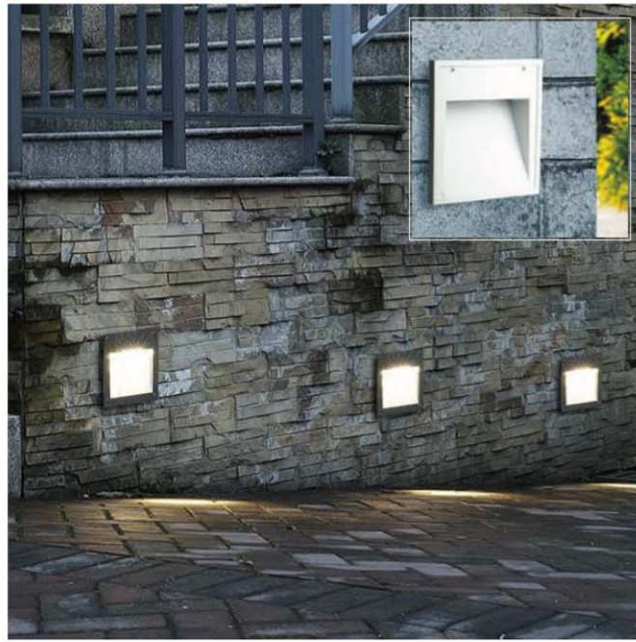

WALL RECESSED TYPE

Item No.	Luminaire	Socket
WR0260CAT	CFL/LED	1*E27

CREE XBD LED Driver included



WR9260CAT 12W
WR9260CAT 20W

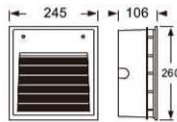

CREE 4LED, 12W

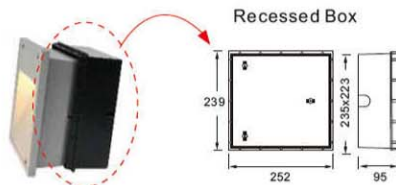
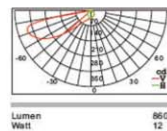

CREE 8LED, 20W

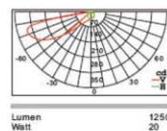

Item No.	Watt	LED	Kelvin	Luminous flux	Beam Angle	CRI	Input	Safety type	Certification
WR9260CAT12W WR9260CAT20W	12W 20W	CREE 4LED CREE 8LED	3000K 4000K	860lm 1250lm	31°	≥80	100-240V	IP65	CE LED
Item No.	Luminaire	Length Max.	Socket	Beam Angle	Input	Safety type	Certification		
WR0260CAT.E27 WR0260CAT.G24	CFL/LED CFL/LED	L=130mm L=150mm	1*E27 1*G24	31°	110V/240V	IP65	CE ETL		

2020 Version

LED Recess Wall Mounted Step Lighting

AC220-240V 50/60 Hz PF >0.9 Ra>80 IP65

3000-3500K 4000-4500K 5000-5500K 6000-6500K

CORSICA



E27



MATERIALS/FINISHES:

- Body in die cast aluminum
- Powder coated for outdoor use
- Diffuser in Prismatic temper glass
- LED driver certified CE/SAA

Diffuser Material:
Prismatic temper glass
Frost PC

Outlook Color:

- Black
 - Light Grey
 - Silver Grey
 - Dark Grey
 - White
- RAL9005 RAL7047 RAL9006 RAL7012 RAL9016



LED & Drivers:

- LED Driver included
- Application Picture

- LED Type:
• SMD 2835



FEATURES:

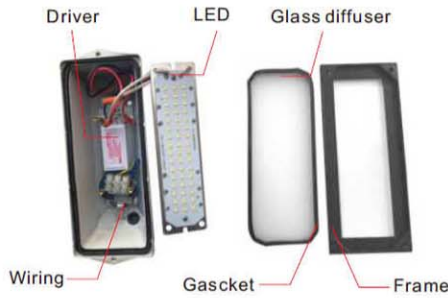

WALL RECESSED TYPE

Item No.	Luminaire	Socket
WR0235CSC/Q	CFL/LED	1*E27

(same to be A/B/C)

■ SMD2835 LED
Driver included

5



WR5235CSC/QA

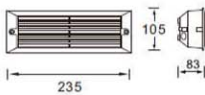

WR5235CSC/QB

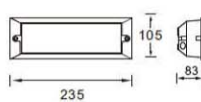

WR5235CSC/QC

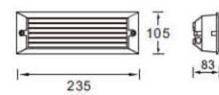

Item No.	Watt	LED	Kelvin	Luminous flux	Beam Angle	CRI	Input	Safety type
WR5235CSC/Q (the same to be A/B/C)	6W 12W	SMD2835	3000K or 4000K	95lm 408lm 408lm	70.4° 76.3° 76.3°	≥80	100-240V	IP65

Item No.	Luminaire	Length Max.	Socket	Beam Angle	Input	Safety type	Certification
WR0235CSC/Q.E27	CFL/LED	L=130mm	1*E27	31°	110V/240V	IP65	CE
WR0235CSC/Q.G24 (the same to be A/B/C)	CFL/LED	L=150mm	1*G24				ETL

2020 Version

LED Recess Wall Mounted Step Lighting

AC220-240V 50/60 Hz PF >0.9 Ra>80 IP65

3000-3500K 4000-4500K 5000-5500K 6000-6500K

DOME

IP65



MATERIALS/FINISHES:

- Body in die cast aluminum
- Powder coated for outdoor use
- Diffuser in Clear PC/Glass
- Silicon rubber gasket
- LED driver certified CE/SAA

LED Color:

- 3000K
- 4000K

Diffuser Material:

- Clear PC/PMMA
- Frost glass

Outlook Color:

- Black
 - Light Grey
 - Silver Grey
 - Dark Grey
 - White
- RAL9005 RAL7047 RAL9006 RAL7012 RAL9016

LED & Drivers:

LED Driver included

LED Type:

Application Picture

- SMD 2835



FEATURES:



WALL RECESSED TYPE



WR5210DME/Q75A

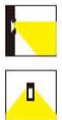
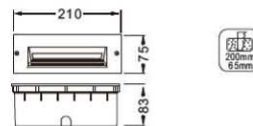

WR5210DME/Q75B

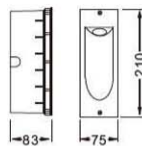

WR5210DME/Q75C

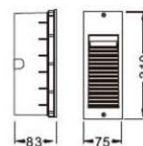

Item No.	Watt	LED	Kelvin	Luminous flux	Beam Angle	CRI	Input	Safety type
WR5210DME/Q75A	10W	SMD 20LED	3000K	350lm	37°	≥80	100-240V	IP65
WR5210DME/Q75B	6W	SMD6LED	4000K	258.6lm	55.45°			
WR5210DME/Q75C	10W	SMD 20LED		350lm	37°			

2020 Version

isa

Hackett & isa

Remark: Specification change without prior notice.

www.hackett-light.com

LED Recess Wall Mounted Step Lighting

AC220-240V 50/60 Hz PF >0.9 Ra>80 IP65

3000-3500K 4000-4500K 5000-5500K 6000-6500K

FOK



CLASS 1 EEC A IP65 IK 08 CE

MATERIALS/FINISHES:

- Body in extruded aluminum
- Powder coated for outdoor use
- Diffuser in Prismatic temper glass
- Silicon rubber gasket
- LED driver certified CE/SAA

LED Color:

- 3000K
- 4000K

LED Driver ex-cluded

Diffuser Material:

Outlook Color:

- Black
 - Light Grey
 - Silver Grey
 - Dark Grey
 - White
- RAL9005 RAL7047 RAL9006 RAL7012 RAL9016

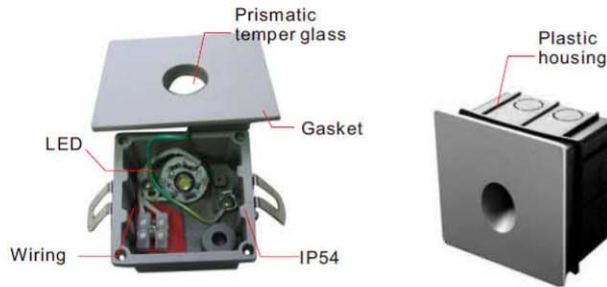

FEATURES:

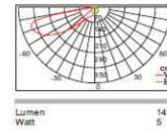
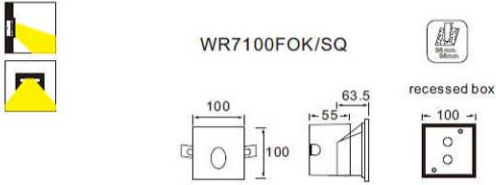

Item No.	Watt	LED	Kelvin	Luminous flux	Beam Angle	CRI	Input	Safety type
WR7100FOK/SQ	5W	CREE 1LED	3000K or 4000K	140lm	36°	≥80	100-240V	IP65

FARM



CLASS 1 EEC A IP54 IK 08 CE

MATERIALS/FINISHES:

- Body in extruded aluminum
- Powder coated for outdoor use
- Diffuser in Prismatic temper glass
- Silicon rubber gasket
- LED driver certified CE/SAA

LED Color:

- 3000K
- 4000K

LED Driver included

Diffuser Material:

Outlook Color:

- Black
 - Light Grey
 - Silver Grey
 - Dark Grey
 - White
- RAL9005 RAL7047 RAL9006 RAL7012 RAL9016

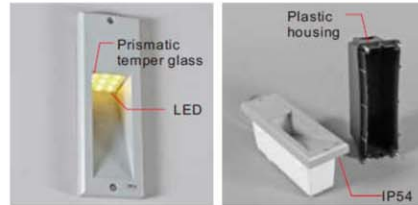

FEATURES:

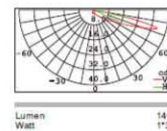
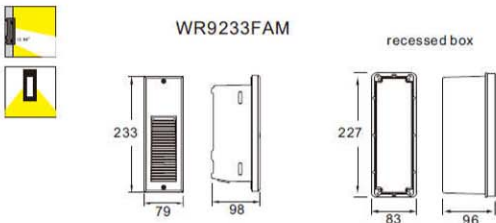

h(m)	Eavg(x)	Emax(x)	D(m)
1	2.036	2.182	0.23
2	0.5091	0.5456	0.45
3	0.2263	0.2425	0.68
4	0.1273	0.1364	0.9
5	0.0815	0.0873	1.13

Item No.	Watt	LED	Kelvin	Luminous flux	Beam Angle	CRI	Input	Safety type
WR9233FAM	3W	CREE 1LED	3000K or 4000K	140 lm	12.84°	≥80	100-240V	IP65

2020 Version



Remark: Specification change without prior notice.

www.hackett-light.com

LED Recess Wall Mounted Step Lighting

AC220-240V 50/60 Hz PF >0.9 Ra>80 IP65

3000-3500K 4000-4500K 5000-5500K 6000-6500K

FRAME.REC



IP65



MATERIALS/FINISHES:

- Body in extruded aluminum
- Powder coated for outdoor use
- Diffuser in Frost PC/PMMA
- Silicon rubber gasket
- LED driver certified CE/SAA

■ **Diffuser Material:**
Frost PC/PMMA

■ **Outlook Color:**
Stainless steel 304

■ **LED Color:**
3000K/4000K

- 3000K
- 4000K

LED & Drivers:

■ **LED Driver included**

■ **Application Picture**

■ **LED Type:**

- SMD 2835

FEATURES:

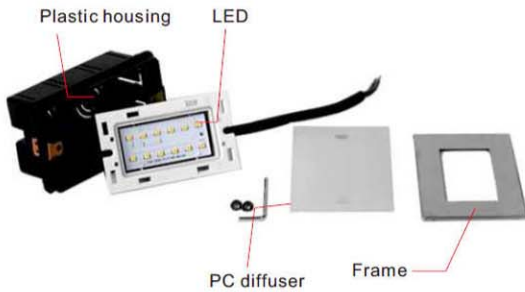

WALL RECESSED TYPE

■ **LED Driver ex-cluded**

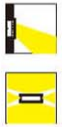

WR5123FRM/QA

WR5123FRM/QB

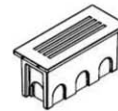
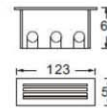
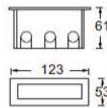

Item No.	Watt	LED	Kelvin	Luminous flux	Beam Angle	CRI	Input	Safety type
WR7123FRM/QA WR7123FRM/QB	1.5W	SMD 12LEDs	or 3000K 4000K	42lm 75lm	135°	≥80	220-240V	IP65

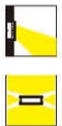

WR5205FRM/QA

WR5205FRM/QB

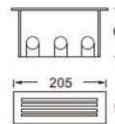
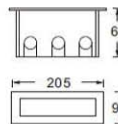

Item No.	Watt	LED	Kelvin	Luminous flux	Beam Angle	CRI	Input	Safety type
WR7205FRM/QA WR7205FRM/QB	3.5W	SMD 56LEDs	or 3000K 4000K	136lm 195lm	135°	≥80	220-240V	IP65

2020 Version

isa

Hackett & isa

Remark: Specification change without prior notice.

www.hackett-light.com

LED Recess Wall Mounted Step Lighting

AC220-240V 50/60 Hz PF >0.9 Ra>80 IP65

3000-3500K 4000-4500K 5000-5500K 6000-6500K

FRAME.SQ



7

IP65



- MATERIALS/FINISHES:**
 - Body in extruded aluminum
 - Powder coated for outdoor use
 - Diffuser in Frost PC/PMMA
 - Silicon rubber gasket
 - LED driver certified CE/SAA
- Diffuser Material:** Frost PC/PMMA
- Outlook Color:** Stainless steel 304

- LED Color:** 3000K/4000K
- 3000K
- 4000K

LED & Drivers:

- LED Driver included**
- Application Picture**
- LED Type:** SMD 2835



FEATURES:

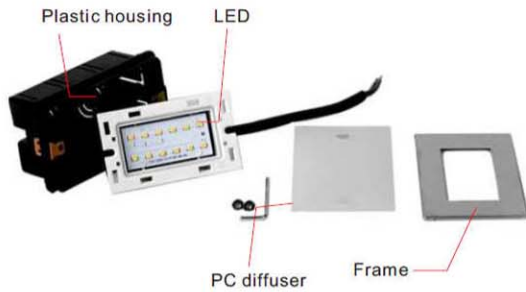

WALL RECESSED TYPE

- LED Driver ex-cluded**



WR5080FRM/SQA WR5080FRM/SQB

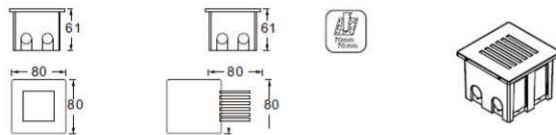

Item No.	Watt	LED	Kelvin	Luminous flux	Beam Angle	CRI	Input	Safety type
WR7080FRM/SQA WR7080FRM/SQB	1.5W	SMD 12LEDs	3000K or 4000K	42lm 75lm	135°	≥80	220-240V	IP65



WR5135FRM/SQA WR5135FRM/SQB

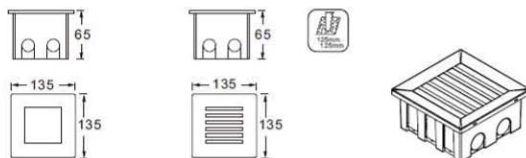

Item No.	Watt	LED	Kelvin	Luminous flux	Beam Angle	CRI	Input	Safety type
WR7135FRM/SQA WR7135FRM/SQB	3.5W	SMD 56LEDs	3000K or 4000K	136lm 195lm	135°	≥80	220-240V	IP65

2020 Version



Remark: Specification change without prior notice.

www.hackett-light.com

LED Recess Wall Mounted Step Lighting

AC220-240V 50/60 Hz PF >0.9 Ra>80 IP65

3000-3500K 4000-4500K 5000-5500K 6000-6500K

ALDA



E27



MATERIALS/FINISHES:

- Body in die cast aluminum
- Powder coated for outdoor use
- Diffuser in Frost temper glass
- Silicon rubber gasket
- LED driver certified CE/SAA

■ **Diffuser Material:**
Frost temper glass
Frost PC

Outlook Color:

- Black
 - Light Grey
 - Silver Grey
 - Dark Grey
 - White
- RAL9005 RAL7047 RAL9006 RAL7012 RAL9016



LED & Drivers:

- LED Driver included
- Application Picture

- LED Type:
• SMD 2835



FEATURES:

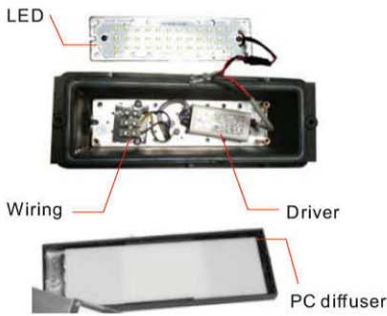

WALL RECESSED TYPE

Item No.	Luminaire	Socket
WR0233ALD	CFL/LED	1*E27

(same to be QA/QB/QC)

- SMD2835 LED Driver included

5



WR5233ALD/QA
WR0233ALD/QA

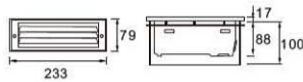

WR5233ALD/QB
WR0233ALD/QB

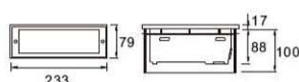

WR5233ALD/QC
WR0233ALD/QC

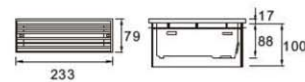

Item No.	Watt	LED	Kelvin	Luminous flux	Beam Angle	CRI	Input	Safety type
WR5233ALD/Q (the same to be A/B/C)	6W 12W	SMD2835	3000K or 4000K	95lm 408lm 408lm	70.4° 76.3° 76.3°	≥80	100-240V	IP65

Item No.	Luminaire	Length Max.	Socket	Beam Angle	Input	Safety type	Certification
WR0233ALD/Q.E27 WR0233ALD/Q.G24 (the same to be QA/QB/QC)	CFL/LED CFL/LED	L=130mm L=150mm	1*E27 1*G24	---°	110V/240V	IP65	CE ETL

2020 Version

LED Recess Wall Mounted Step Lighting

AC220-240V 50/60 Hz PF >0.9 Ra>80 IP65

3000-3500K 4000-4500K 5000-5500K 6000-6500K

HOVA

IP65



MATERIALS/FINISHES:

- Body in extruded aluminum
- Powder coated for outdoor use
- Diffuser in Clear temper glass
- Silicon rubber gasket
- LED driver certified CE/SAA

LED Color: 3000K/4000K

- 3000K
- 4000K

LED & Drivers:

- LED Driver included
- Application Picture

LED Type:

- CREE 1*2W

Diffuser Material: Clear Temper glass

Outlook Color:

- Black
 - Light Grey
 - Silver Grey
 - Dark Grey
 - White
- RAL9005 RAL7047 RAL9006 RAL7012 RAL9016

FEATURES:

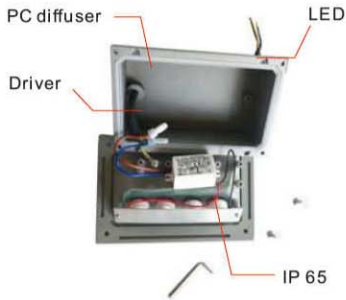

WALL RECESSED TYPE

LED Driver included



WR9114HOV/SQ

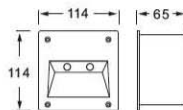

SMD15LED 3W 140lm

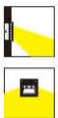
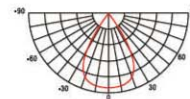

WR9170HOV

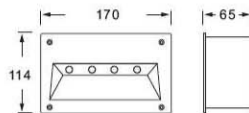

SMD10LED 2W 50lm

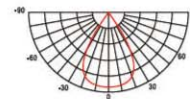

Item No.	Watt	LED	Kelvin	Luminous flux	Beam Angle	CRI	Input	Safety type
WR9114HOV/SQ	2*2W	CREE2LEDs	3000K	169lm	29°	≥80	110V/230V	IP65
WR9170HOV	4*2W	CREE4LEDs	or 4000K	327lm	31°			

2020 Version

LED Recess Wall Mounted Step Lighting

AC220-240V 50/60 Hz PF >0.9 Ra>80 IP65

3000-3500K 4000-4500K 5000-5500K 6000-6500K

LOGOS

IP65 LED



MATERIALS/FINISHES:

- Body in extruded aluminum
- Powder coated for outdoor use
- Diffuser in PC+Clear temper glass
- Silicon rubber gasket
- LED driver certified CE/SAA

LED Color:

- 3000K
- 4000K

LED & Drivers:

- LED Driver included
- Application Picture

LED Type:

- SMD

Diffuser Material:

PC +Temper glass diffuser

Outlook Color:

- Black
 - Light Grey
 - Silver Grey
 - Dark Grey
 - White
- RAL9005 RAL7047 RAL9006 RAL7012 RAL9016



FEATURES:

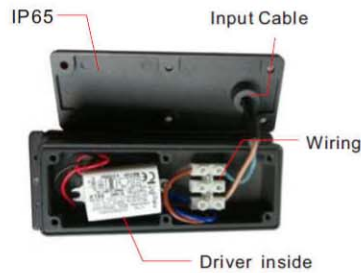
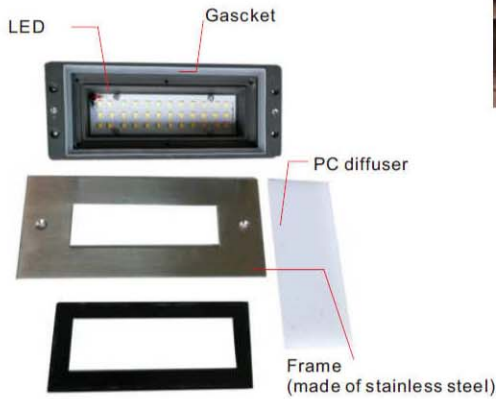

WALL RECESSED TYPE

- LED Driver included

5

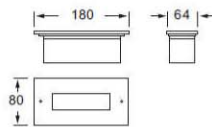

WR5180LGS/Q80

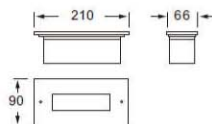

WR5210LGS/Q90



Item No.	Watt	LED	Kelvin	Luminous flux	Beam Angle	CRI	Input	Safety type
WR5180LGS/Q80	6W	SMD 21LEDs	3000K	360lm	120°	≥80	110V/230V	IP65
WR5210LGS/Q90	12W	SMD 48LEDs	4000K	600lm				



2020 Version

LED Recess Wall Mounted Step Lighting

AC220-240V 50/60 Hz PF >0.9 Ra>80 IP65

3000-3500K 4000-4500K 5000-5500K 6000-6500K

LUXOR

IP65



MATERIALS/FINISHES:

- Body in extruded aluminum
- Powder coated for outdoor use
- Diffuser in PC/Frost temper glass
- Silicon rubber gasket
- LED driver certified CE/SAA

LED Color: 3000K/4000K

- 3000K
- 4000K

Diffuser Material:

PC/ Frost temper glass

Outlook Color:

- Black
 - Light Grey
 - Silver Grey
 - Dark Grey
 - White
- RAL9005 RAL7047 RAL9006 RAL7012 RAL9016

LED & Drivers:

- LED Driver included
- Application Picture

LED Type:

- SMD LED



FEATURES:



WALL RECESSED TYPE

SMD2835 LED, Driver included

5

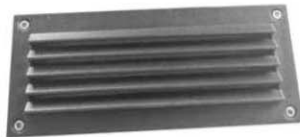
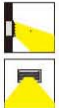

WR5190LUX/Q78A

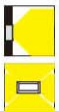
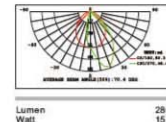
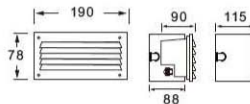

WR5190LUX/Q78B

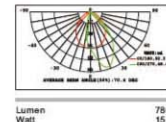
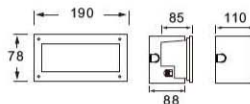

Item No.	Watt	LED	Kelvin	Luminous flux	Beam Angle	CRI	Input	Safety type
WR5190LUX/Q78A	15W	SMD 72LEDs	3000K	280lm	29°	≥80	100-240V	IP65
WR5190LUX/Q78B			4000K	780lm	105°			

2020 Version

LED Recess Wall Mounted Step Lighting

AC220-240V 50/60 Hz PF >0.9 Ra>80 IP65

3000-3500K 4000-4500K 5000-5500K 6000-6500K

RIGA



MATERIALS/FINISHES:

- Body in die cast aluminum
- Powder coated for outdoor use
- Diffuser in Frost PC/PMMA
- Silicon rubber gasket
- LED driver certified CE/SAA

LED Color: 3000K/4000K

- 3000K
- 4000K

LED & Drivers:

- LED Driver included
- Application Picture

LED Type:

- CREE LED

Diffuser Material: Frost PC/PMMA

Outlook Color:

- Black
 - Light Grey
 - Silver Grey
 - Dark Grey
 - White
- RAL9005 RAL7047 RAL9006 RAL7012 RAL9016

FEATURES:

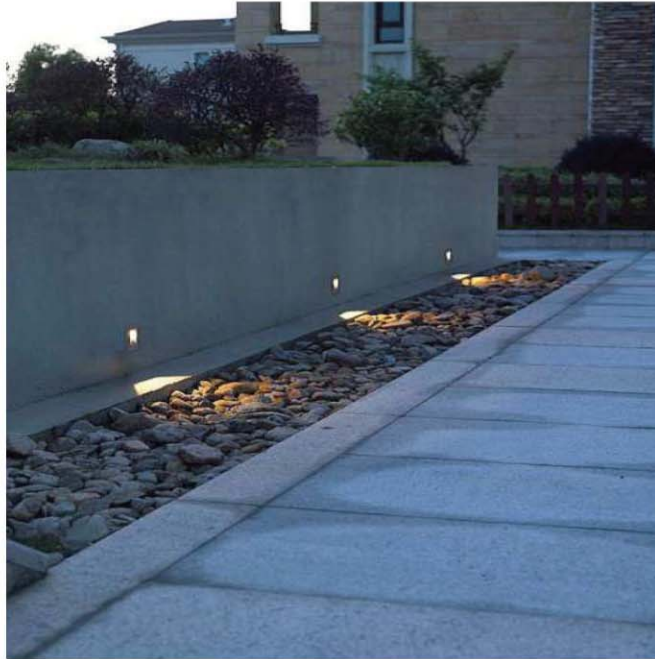

WALL RECESSED TYPE

CREE LED, Driver included

9



WR5126RIG/R

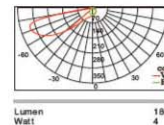
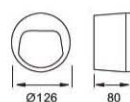

WR5126RIG/SQ

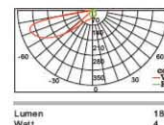
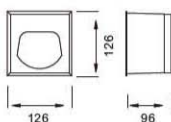

Item No.	Watt	LED	Kelvin	Luminous flux	Beam Angle	CRI	Input	Safety type
WR9126RIG/R WR9126RIG/SQ	4W	CREE 3LEDs	3000K or 4000K	180lm	100°	≥80	100-240V	IP65

2020 Version

LED Recess Wall Mounted Step Lighting

AC220-240V 50/60 Hz PF >0.9 Ra>80 IP65

3000-3500K 4000-4500K 5000-5500K 6000-6500K

RIYAD-I

IP65



MATERIALS/FINISHES:

- Body in die cast aluminum
- Powder coated for outdoor use
- Diffuser in Prismatic temper glass
- Silicon rubber gasket
- LED driver certified CE/SAA

LED Color: 3000K/4000K

- 3000K
- 4000K

Diffuser Material:

Prismatic temper glass

Outlook Color:

- Black
 - Light Grey
 - Silver Grey
 - Dark Grey
 - White
- RAL9005 RAL7047 RAL9006 RAL7012 RAL9016

LED & Drivers:

- LED Driver included
- Application Picture

LED Type:

- SMD 2835



FEATURES:



WALL RECESSED TYPE

- LED Driver included 5

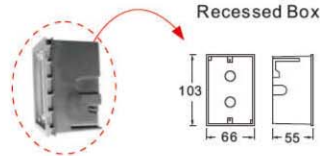
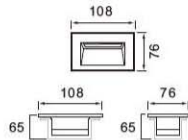

Item No.	Watt	LED	Kelvin	Luminous flux	Beam Angle	CRI	Input	Safety type
WR5108RYD/Q76	3W	SMD15LEDs	3000K or 4000K	140lm	---°	≥80	220-240V	IP65

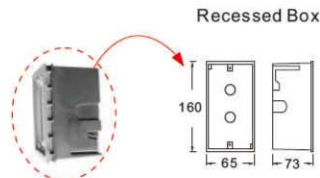
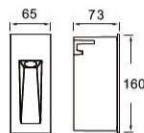

Item No.	Watt	LED	Kelvin	Luminous flux	Beam Angle	CRI	Input	Safety type
WR5160RYD/QC	2W	SMD10LEDs	3000K or 4000K	50lm	---°	≥80	200-240V	IP65

2020 Version

LED Recess Wall Mounted Step Lighting

AC220-240V 50/60 Hz PF >0.9 Ra>80 IP65

3000-3500K 4000-4500K 5000-5500K 6000-6500K

RIYAD-II

IP65



MATERIALS/FINISHES:

- Body in die cast aluminum
- Powder coated for outdoor use
- Diffuser in Prismatic temper glass
- Silicon rubber gasket
- LED driver certified CE/SAA

LED Color: 3000K/4000K

- 3000K
- 4000K

LED & Drivers:

- LED Driver included
- Application Picture

LED Type:

- SMD 2835

Diffuser Material:

Prismatic temper glass

Outlook Color:

- Black
 - Light Grey
 - Silver Grey
 - Dark Grey
 - White
- RAL9005 RAL7047 RAL9006 RAL7012 RAL9016

FEATURES:

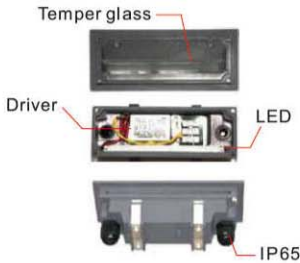

WALL RECESSED TYPE



LED Driver included **5**

WR5160RYD/QA

WR5160RYD/QB

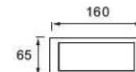
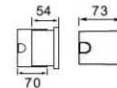
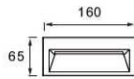

Item No.	Watt	LED	Kelvin	Luminous flux	Beam Angle	CRI	Input	Safety type
WR5160RYD/QA WR5160RYD/QB	5W	SMD20LEDs	or 3000K 4000K	180lm	100°	≥80	220-240V	IP65



WR5280RYD/QA

WR5280RYD/QB

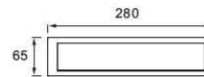
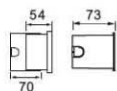
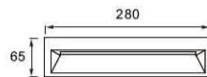

Item No.	Watt	LED	Kelvin	Luminous flux	Beam Angle	CRI	Input	Safety type
WR5280RYD/QA WR5280RYD/QB	10W	SMD30LEDs	or 3000K 4000K	400lm	100°	≥80	220-240V	IP65

2020 Version

isa

Hackett & isa

Remark: Specification change without prior notice.

www.hackett-light.com

LED Recess Wall Mounted Step Lighting

AC220-240V 50/60 Hz PF >0.9 Ra>80 IP65

3000-3500K 4000-4500K 5000-5500K 6000-6500K

SEASTAR

IP68

LED

7

CLASS I EEC A IP68 IK 08 CE

MATERIALS/FINISHES:

- Body in extruded aluminum
- Powder coated for outdoor use
- Diffuser in Frost PC/PMMA
- Silicon rubber gasket
- LED driver certified CE/SAA

LED Color:

- 3000K
- 4000K

LED & Drivers:

- LED Driver included
- Application Picture

LED Type:

- SMD2835

Diffuser Material:

- Clear PC/PMMA

Outlook Color:

- Stainless steel

FEATURES:



WALL RECESSED TYPE

LED Driver ex-cluded

7



WR7146SST/Q60

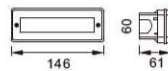

SMD18LED 1.5W

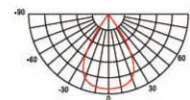

WR7196SST/Q70

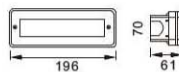

SMD39LED 2.3W

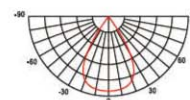

Item No.	Watt	LED	Kelvin	Luminous flux	Beam Angle	CRI	Input	Safety type
WR7146SST/Q60	1.5W	CREE18LEDs	3000K	60lm	120°	≥80	110V/230V	IP68
WR7196SST/Q70	2.3W	CREE39LEDs	4000K	130lm	120°	≥80	110V/230V	IP68

2020 Version

LED Recess Wall Mounted Step Lighting

AC220 ~240V 50/60 Hz PF >0.9 Ra>80 IP65

3000-3500K 4000-4500K 5000-5500K 6000-6500K

SLOT



7



MATERIALS/FINISHES:

- Body in die cast aluminum
- Powder coated for outdoor use
- Diffuser in Clear temper glass
- Silicon rubber gasket
- LED driver certified CE/SAA

LED Color:

- 3000K
- 4000K

LED & Drivers:

- LED Driver included
- Application Picture

LED Type:

- SMD LED

Diffuser Material:

Clear temper glass

Outlook Color:

- Black
 - Light Grey
 - Silver Grey
 - Dark Grey
 - White
- RAL9005 RAL7047 RAL9006 RAL7012 RAL9016

FEATURES:

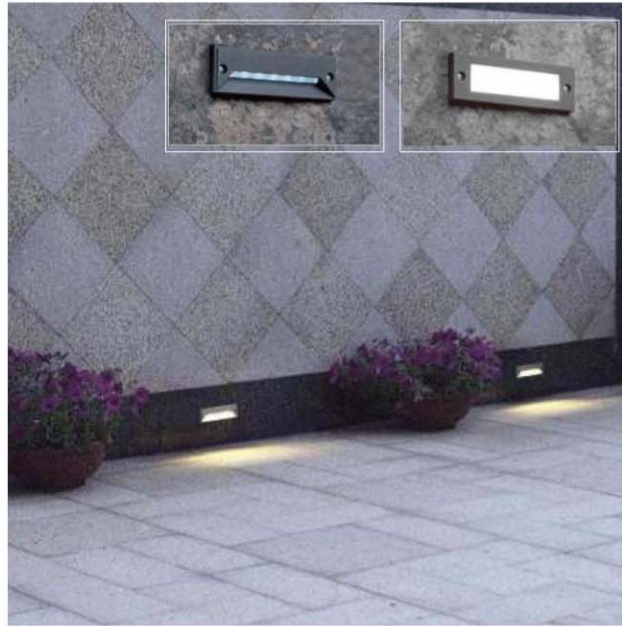

WALL RECESSED TYPE

LED Driver ex-cluded

7



WR7145SLT/QA

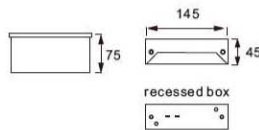

SMD 12LED 1W

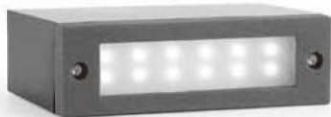
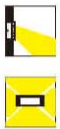
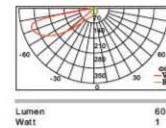

WR7145SLT/QB

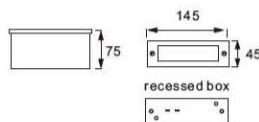

SMD 12LED 1W

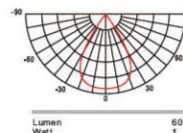

Item No.	Watt	LED	Kelvin	Luminous flux	Beam Angle	CRI	Input	Safety type
WR7145SLT/QA WR7145SLT/QB	1W	SMD2835	or 3000K 4000K	60lm	36° 120°	≥80	110V/230V	IP65

2020 Version

LED Recess Wall Mounted Step Lighting

AC220-240V 50/60 Hz PF >0.9 Ra>80 IP65

3000-3500K 4000-4500K 5000-5500K 6000-6500K

SOFIA



MATERIALS/FINISHES:

- Body in die cast aluminum
- Powder coated for outdoor use
- Diffuser in Frost temper glass
- Silicon rubber gasket
- LED driver certified CE/SAA

LED Color: 3000K/4000K

- 3000K
- 4000K

LED & Drivers:

- LED Driver included
- Application Picture

LED Type:

- CREE LED

Diffuser Material: Frost temper glass

Outlook Color:

- Black
 - Light Grey
 - Silver Grey
 - Dark Grey
 - White
- RAL9005 RAL7047 RAL9006 RAL7012 RAL9016

FEATURES:

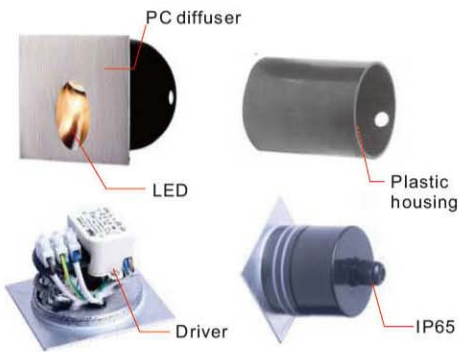

WALL RECESSED TYPE

CREE LED, Driver included

9

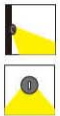

WR9080SFI/R0



WR9080SFI/R1

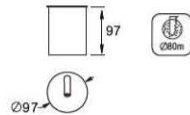

WR9080SFI/R



Item No.	Watt	LED	Kelvin	Luminous flux	Beam Angle	CRI	Input	Safety type
WR9080SFI/R0 WR9080SFI/R1	3W	CREE 1LED	or 3000K 4000K	78lm	30°	≥80	100-240V	IP65

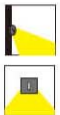

WR9080SFI/SQ0



WR9080SFI/SQ1

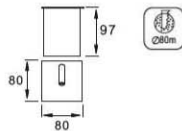

WR5080SFI/SQ



Item No.	Watt	LED	Kelvin	Luminous flux	Beam Angle	CRI	Input	Safety type
WR9080SFI/SQ0 WR9080SFI/SQ1	3W	CREE 1LED	or 3000K 4000K	78lm	30°	≥80	100-240V	IP65



2020 Version

isa

Hackett & isa

Remark: Specification change without prior notice.

www.hackett-light.com

LED Recess Wall Mounted Step Lighting

AC220-240V 50/60 Hz PF >0.9 Ra>80 IP65

3000-3500K 4000-4500K 5000-5500K 6000-6500K

SPRING



MATERIALS/FINISHES:

- Body in extruded aluminum
- Powder coated for outdoor use
- Diffuser in Frost PC/Temper glass
- Silicon rubber gasket
- LED driver certified CE/SAA

Diffuser Material:

- Frost PC/PMMA
- Frost temper glass

LED Color:

- 3000K
- 4000K

Outlook Color:

- Stainless steel 304

LED & Drivers:

- LED Driver included
- Application Picture

LED Type:

- SMD2835



FEATURES:

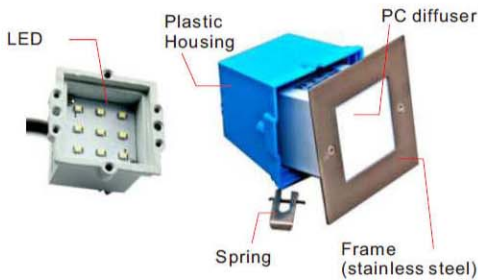

WALL RECESSED TYPE

LED Driver ex-cluded 7

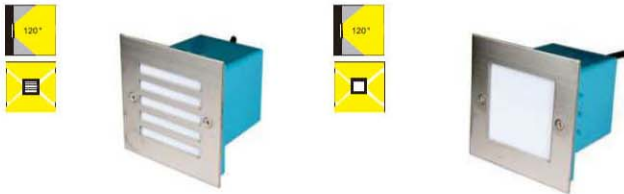

WR7070SPR/SQA
WR7105SPR/SQA

WR7070SPR/SQB
WR7105SPR/SQB

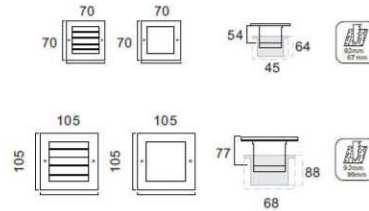

Item No.	Watt	LED	Kelvin	Luminous flux	Beam Angle	CRI	Input	Safety type
WR7070SPR/SQA(B)	0.8W	SMD 9LEDs	or 3000K	45lm	120°	≥80	110V/230V	IP65
WR7105SPR/SQA(B)	1.5W	SMD 16LEDs	4000K	80lm				

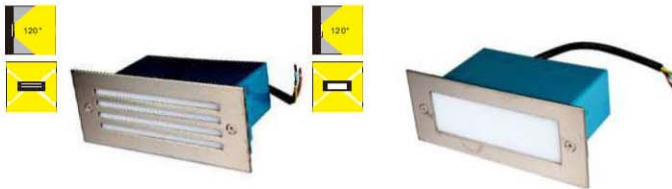

WR5111SPR/Q44B
WR5170SPR/Q68B

WR5111SPR/Q44A
WR5170SPR/Q68A

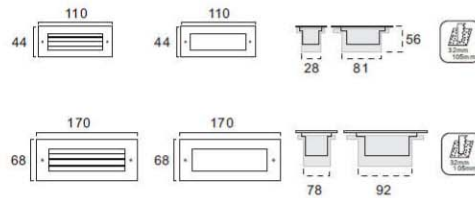

Item No.	Watt	LED	Kelvin	Luminous flux	Beam Angle	CRI	Input	Safety type
WR7110SPR/Q44A(B)	1W	SMD 12LEDs	or 3000K	60lm	120°	≥80	110V/230V	IP65
WR7170SPR/Q68A(B)	1.5W	SMD 16LEDs	4000K	90lm				

2020 Version

LED Recess Wall Mounted Step Lighting

AC220-240V 50/60 Hz PF >0.9 Ra>80 IP65

3000-3500K 4000-4500K 5000-5500K 6000-6500K

TOKYO

IP65



MATERIALS/FINISHES:

- Body in die cast aluminum
- Powder coated for outdoor use
- Diffuser in Clear PC/Glass
- Silicon rubber gasket
- LED driver certified CE/SAA

LED Color: 3000K/4000K

- 3000K
- 4000K

LED & Drivers:

- LED Driver included
- Application Picture

LED Type:

- SMD 2835

Diffuser Material:

- Clear PC/PMMA
- Frost glass

Outlook Color:

- Black
- Light Grey
- Silver Grey
- Dark Grey
- White



FEATURES:



WALL RECESSED TYPE

- LED Driver included 5

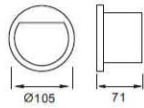
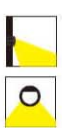

WR5105TKY/R

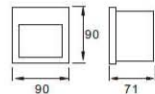
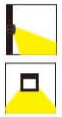

WR5090TKY/SQ

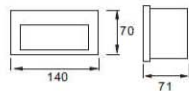
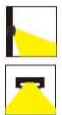

WR5140TKY/Q70



Item No.	Watt	LED	Kelvin	Luminous flux	Beam Angle	CRI	Input	Safety type
WR5105TKY/R WR5090TKY/SQ WR5140TKY/Q70	3W	SMD 12LED	3000K or 4000K	105lm	37°	≥80	100-130V 220-240V	IP65

2020 Version

LED Recess Wall Mounted Step Lighting

AC220-240V 50/60 Hz PF >0.9 Ra>80 IP65

3000-3500K 4000-4500K 5000-5500K 6000-6500K

VERSO.LQ



MATERIALS/FINISHES:

- Body in extruded aluminum
- Powder coated for outdoor use
- Diffuser in Frost temper glass
- Silicon rubber gasket
- LED driver certified CE/SAA

LED Color:

- 3000K
- 4000K

Diffuser Material:

Prismatic temper glass

Outlook Color:

- Black
 - Light Grey
 - Silver Grey
 - Dark Grey
 - White
- RAL9005 RAL7047 RAL9006 RAL7012 RAL9016

LED & Drivers:

LED Driver included

Application Picture

LED Type:

- CREE LED



WALL RECESSED TYPE

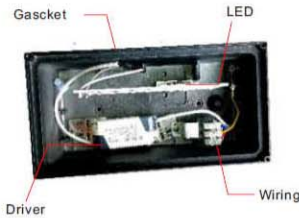

WALL RECESSED TYPE

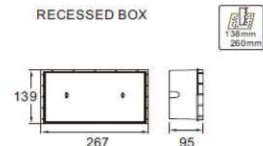
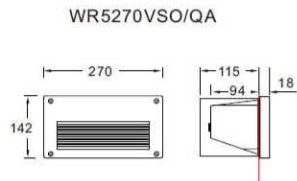
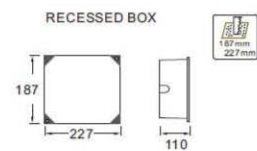
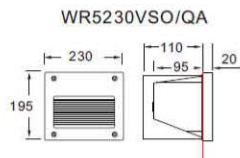
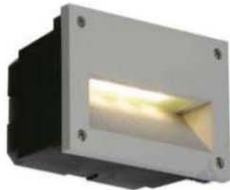

Item No.	Luminaire	Socket	■ CREE LED Driver included	9
WR0270LVS WR0230LVS	CFL/LED	1*E27		

Item No.	Watt	LED	Kelvin	Luminous flux	Beam Angle	CRI	Input	Safety type
WR9270LVS/QA WR9230LVS/QA	12W 20W	CREE	3000K or 4000K	---lm ---lm	---°	≥80	110V/230V	IP65
Item No.	Luminaire	Length Max.	Socket	Beam Angle	Input	Safety type	Certification	
WR0270LVS/QA WR0230LVS/QA	CFL/LED	L=150mm	1*E27/G24q	---°	110V/240V	IP65		

2020 Version



Remark: Specification change without prior notice.

www.hackett-light.com

LED Recess Wall Mounted Step Lighting

AC220-240V 50/60 Hz PF >0.9 Ra>80 IP65

3000-3500K 4000-4500K 5000-5500K 6000-6500K

VERSO.SQ



E27



MATERIALS/FINISHES:

- Body in extruded aluminum
- Powder coated for outdoor use
- Diffuser in Frost temper glass
- Silicon rubber gasket
- LED driver certified CE/SAA



Diffuser Material:

Prismatic temper glass

Outlook Color:

- Black RAL9005
- Light Grey RAL7047
- Silver Grey RAL9006
- Dark Grey RAL7012
- White RAL9016

FEATURES:

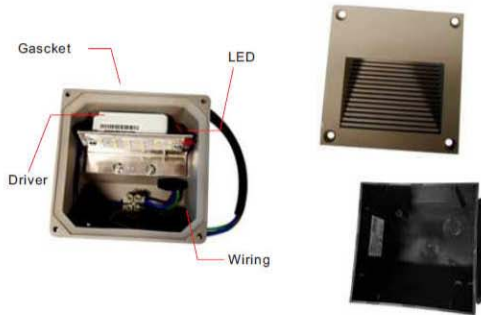

LED & Drivers:

- LED Driver included
- Application Picture

LED Type:

- SMD 2835



WALL RECESSED TYPE

- LED Driver included

5



WR5110VSO/SQ

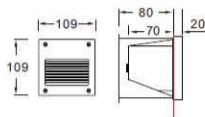

RECESSED BOX

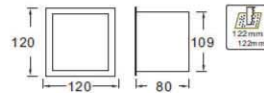

Item No.	Watt	LED	Kelvin	Luminous flux	Beam Angle	CRI	Input	Safety type
WR5109VSO/SQ	6W	SMD2835	or 3000K 4000K	160.9lm	46.4°	≥80	100-240V	IP65



WR5206VSO/SQ

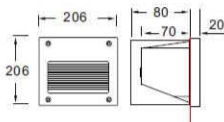

RECESSED BOX

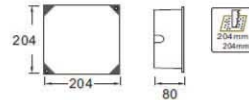

Item No.	Watt	LED	Kelvin	Luminous flux	Beam Angle	CRI	Input	Safety type
WR5206VSO/SQ	12W	SMD2835	or 3000K 4000K	194.14lm	46.4°	≥80	100-240V	IP65

Item No.	Luminaire	Length Max.	Socket	Beam Angle	Input	Safety type	Certification
WR0206VSO/SQ	CFL/LED	L=150mm	1*E27/G24q	71°	110V/240V	IP65	

2020 Version



Remark: Specification change without prior notice.

www.hackett-light.com

LED Recess Wall Mounted Step Lighting

AC220-240V 50/60 Hz PF >0.9 Ra>80 IP65

3000-3500K 4000-4500K 5000-5500K 6000-6500K

VICTORIA126

IP65

LED

7

CLASS I EEC A IP65 IK 08 CE

MATERIALS/FINISHES:

- Body in die cast aluminum
- Powder coated for outdoor use
- Diffuser in Frost PC
- Silicon rubber gasket
- LED driver certified CE/SAA

LED Color:

- 3000K
- 4000K

LED & Drivers:

- LED Driver included
- Application Picture

LED Type:

- SMD 2835

Diffuser Material:

Clear PC diffuser

Outlook Color:

- Black
 - Light Grey
 - Silver Grey
 - Dark Grey
 - White
- RAL9005 RAL7047 RAL9006 RAL7012 RAL9016

FEATURES:

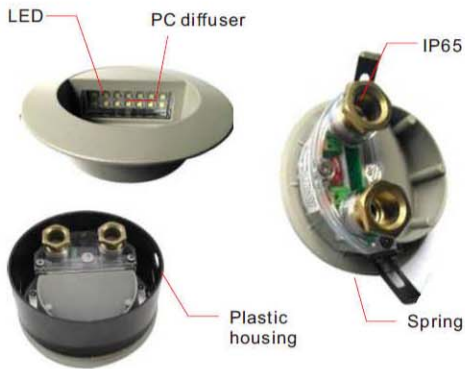

WALL RECESSED TYPE

- LED Driver ex-cluded

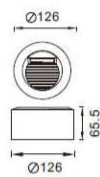

WR5126VTR/R

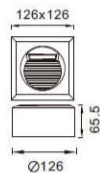

WR5126VTR/SQ

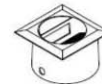

Item No.	Watt	LED	Kelvin	Luminous flux	Beam Angle	CRI	Input	Safety type
WR5126VTR/R WR5126VTR/SQ	1.2W	SMD 14LEDs	3000K or 4000K	75lm	100°	≥80	100-240V	IP65



2020 Version

isa

Hackett & isa

Remark: Specification change without prior notice.

www.hackett-light.com

LED Recess Wall Mounted Step Lighting

AC220-240V 50/60 Hz PF >0.9 Ra>80 IP65

3000-3500K 4000-4500K 5000-5500K 6000-6500K

VICTORIA138

IP65



7

CLASS I EEC A IP65 IK 08 CE

MATERIALS/FINISHES:

- Body in die cast aluminum
- Powder coated for outdoor use
- Diffuser in Frost PC
- Silicon rubber gasket
- LED driver certified CE/SAA

LED Color:

- 3000K
- 4000K

LED & Drivers:

- LED Driver included
- Application Picture

LED Type:

- SMD 2835

Diffuser Material:

Clear PC diffuser

Outlook Color:

- Black
 - Light Grey
 - Silver Grey
 - Dark Grey
 - White
- RAL9005 RAL7047 RAL9006 RAL7012 RAL9016

FEATURES:

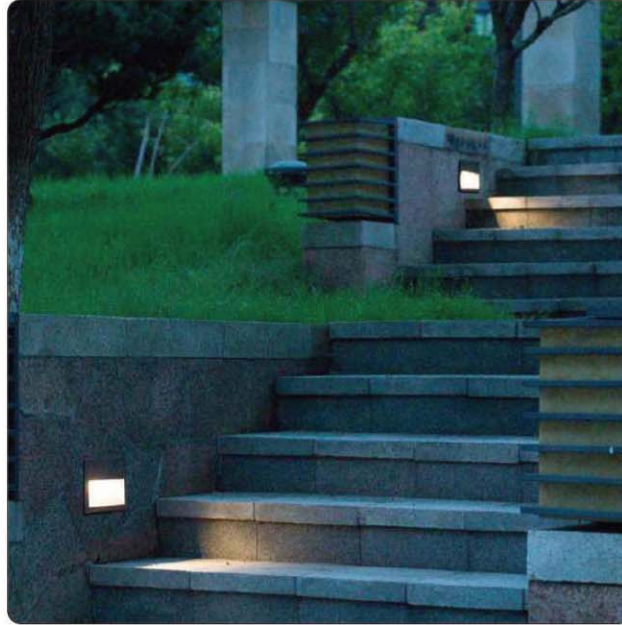

WALL RECESSED TYPE

LED Driver ex-cluded 7

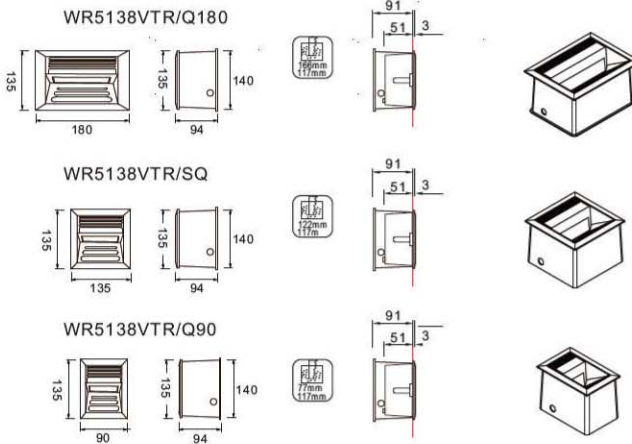
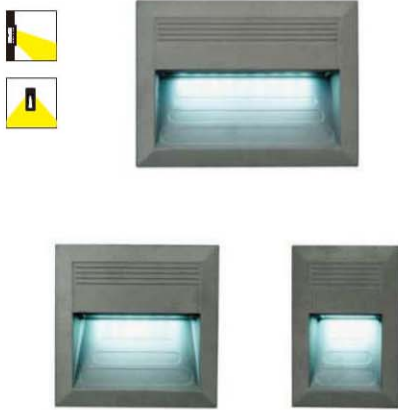

Item No.	Watt	LED	Kelvin	Luminous flux	Beam Angle	CRI	Input	Safety type
WR5138VTR/Q90	1.2W	SMD 15LEDs	or 3000K	75lm	100°	≥80	220-240V	IP65
WR5138VTR/SQ	1.5W	SMD 18LEDs	4000K	90lm				
WR5138VTR/Q180	2.2W	SMD 27LEDs		135lm				
Item No.	Watt	LED	Kelvin	Luminous flux	Beam Angle	CRI	Input	Safety type
WR7138VTR/Q90	3W	SMD 15LEDs	or 3000K	195lm	100°	≥80	220-240V	IP65
WR7138VTR/SQ	6W	SMD 12LEDs	4000K	390lm				
WR7138VTR/Q180	10W	SMD 20LEDs		650lm				

2020 Version

LED Recess Wall Mounted Step Lighting

AC220-240V 50/60 Hz PF >0.9 Ra>80 IP65

3000-3500K 4000-4500K 5000-5500K 6000-6500K

VICTORIA234

IP65



7



MATERIALS/FINISHES:

- Body in die cast aluminum
- Powder coated for outdoor use
- Diffuser in Frost PC
- Silicon rubber gasket
- LED driver certified CE/SAA

LED Color:

- 3000K
- 4000K

LED & Drivers:

- LED Driver included
- Application Picture

LED Type:

- SMD 2835

Diffuser Material:

Clear PC diffuser

Outlook Color:

- Black
 - Light Grey
 - Silver Grey
 - Dark Grey
 - White
- RAL9005 RAL7047 RAL9006 RAL7012 RAL9016

FEATURES:

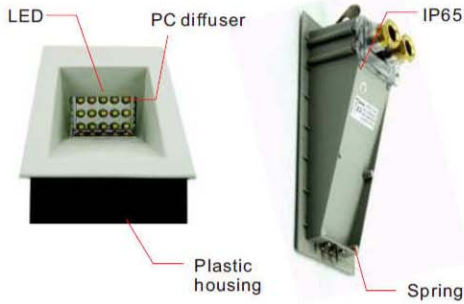

WALL RECESSED TYPE

- LED Driver ex-cluded



ITEM NO.	A	A1	B	C
WR5234VTR/Q90	230	234	90	94
WR5234VTR/Q140	230	234	140	94
WR5234VTR/Q185	230	234	185	94

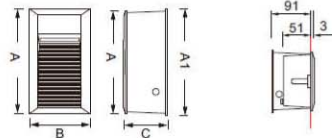
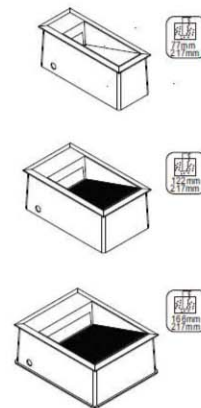

Item No.	Watt	LED	Kelvin	Luminous flux	Beam Angle	CRI	Input	Safety type
WR5234VTR/Q90	1.2W	SMD 15LEDs	3000K	75lm	100°	≥80	220-240V	IP65
WR5234VTR/Q140	1.5W	SMD 18LEDs	4000K	90lm				
WR5234VTR/Q185	2.2W	SMD 27LEDs		135lm				

Item No.	Watt	LED	Kelvin	Luminous flux	Beam Angle	CRI	Input	Safety type
WR7234VTR/Q90	3W	SMD 15LEDs	3000K	195lm	100°	≥80	220-240V	IP65
WR7234VTR/Q140	6W	SMD 12LEDs	4000K	390lm				
WR7234VTR/Q185	10W	SMD 20LEDs		650lm				

2020 Version